



## Operation manual | for operators sonnenBatterie Evo

## IMPORTANT

- ▶ Read this document carefully before operation.
- ▶ Retain this document for reference purposes.

### Publisher

sonnen Australia Pty Ltd

Tenancy 6, Lionsgate Business Park

180 Philip Highway | Elizabeth South SA 5112

Service number

+61 137 666

Email

info@sonnen.com.au

### Document

Document number

5000611

Version

000

Valid for

AU, NZ

Publication date

04/08/2022

## Table of Contents

<b>1</b>	<b>Information about this document</b> .....	<b>5</b>
1.1	Target group of this document.....	5
1.2	Designations in this document.....	5
1.3	Symbols in this document.....	6
<b>2</b>	<b>Safety</b> .....	<b>7</b>
2.1	Intended Use.....	7
2.2	Operating the storage system .....	7
2.3	Important safety instructions.....	8
2.4	Voltage inside the storage system.....	8
2.5	Handling the battery modules.....	9
2.5.1	Information on the sonnenModule 4 battery modules: .....	9
2.6	Conduct in case of a fire.....	10
<b>3</b>	<b>Product Description</b> .....	<b>12</b>
3.1	Technical data.....	12
3.2	Type plate .....	14
3.3	Overview of switch panel .....	14
3.4	System components.....	15
3.5	Symbols on the storage system.....	16
3.6	Function of the LED indicator.....	17
<b>4</b>	<b>Function</b> .....	<b>18</b>
4.1	Basic principle .....	18
4.1.1	Self-consumption mode .....	18
4.1.2	Backup mode.....	19
4.1.3	Time-of-Use mode .....	21
<b>5</b>	<b>Operating the storage system</b> .....	<b>23</b>
5.1	Switching the storage system on .....	23
5.2	Switching the storage system off .....	24

<b>6</b>	<b>Customer portal</b> .....	<b>25</b>
6.1	Logging into the customer portal .....	25
6.2	Using the customer portal .....	26
6.2.1	Dashboard.....	26
6.2.2	Live state.....	26
6.2.3	Performance .....	27
6.2.4	sonnenBatterie page.....	30
6.2.5	Help and Support.....	31
6.2.6	Personalising sonnen account .....	32
<b>7</b>	<b>Maintenance</b> .....	<b>34</b>
<b>8</b>	<b>Decommissioning</b> .....	<b>35</b>
<b>9</b>	<b>Troubleshooting</b> .....	<b>35</b>
<b>10</b>	<b>Uninstallation &amp; Disposal</b> .....	<b>36</b>
10.1	Uninstallation.....	36
10.2	Disposal .....	36

# 1 Information about this document

This document describes the operation of the sonnenBatterie Evo storage system.

- ▶ Read this document in its entirety.
- ▶ Keep this document in the vicinity of the storage system.

## 1.1 Target group of this document

This document is intended for customers who have purchased the storage system.

## 1.2 Designations in this document

The following designations are used in this document:

Complete designation	Designation in this document
sonnenBatterie Evo	Storage system

### 1.3 Symbols in this document



Extremely dangerous situation leading to certain death or serious injury if the safety information is not observed.



Dangerous situation leading to potential death or serious injury if the safety information is not observed.



Dangerous situation leading to potential injury if the safety information is not observed.

**NOTICE**

Indicates actions that may cause material damage.



Important information not associated with any risks to people or property.

Symbol	Meaning
▶	Work step
1.2.3. ...	Work steps in a defined order
✓	Condition
-	List

Table 1: Additional symbols

## 2 Safety

### 2.1 Intended Use

The sonnenBatterie Evo is a battery storage system which can be used to store electrical energy. Improper use of this system poses a risk of death or injury to the user or third parties as well as damage to the product and other items of value. The following points must therefore be observed in order to comply with the intended use of the product:

- The storage system must not be installed in a combination.
- The storage system must be fully installed in accordance with the installation instructions.
- The storage system must be installed by a licensed electrician who has completed the sonnen installer accreditation training. Country-specific regulations concerning electrical installations must be observed at all times.
- The storage system must only be used at a suitable installation location.
- The transport and storage conditions must be observed.

The following uses are not permissible:

- Operation in flammable environments or areas at risk of explosion.
- Operation in locations at risk of flooding.
- Operation in an outdoor location whereby the supplied IP rating of the enclosure has not remained intact.
- Operation of the battery modules outside of its storage system.



Failure to comply with the conditions of the warranty and the information specified in this document invalidates any warranty claims.

---

### 2.2 Operating the storage system

Incorrect operation can lead to injury to yourself or others and cause damage to property:

- The storage system must only be operated as described in the product documentation.

- This device can be used by individuals with impaired physical, sensory or mental capabilities or individuals with limited knowledge and/or experience of working with the device, as long as they are supervised or have been trained to safely use the device and understand the resulting risks of doing so.

## 2.3 Important safety instructions

- Only use the storage system in its original state.
- Do not modify the storage system.
- Do not use a damaged storage system.
- Ensure all safety devices are in perfect working condition.
- Safety devices must never be overridden, blocked or tampered with.
- The interfaces of the storage system must be wired in accordance with the product documentation.
- An appropriate and readily accessible disconnect device shall be incorporated in the fixed wiring.
- All repairs on the storage system must be performed by authorised service technicians only.
- The replacement of battery modules must be performed by authorised service technicians only. When replacing batteries, replace with the same type and number of batteries or battery modules.

## 2.4 Voltage inside the storage system



The storage system contains live electrical parts, which poses a risk of electrical shock. The storage system inverter also contains capacitors which carry voltage even after the storage system is switched off.

- ▶ Do not open the storage system.



## 2.5 Handling the battery modules

### 2.5.1 Information on the sonnenModule 4 battery modules:

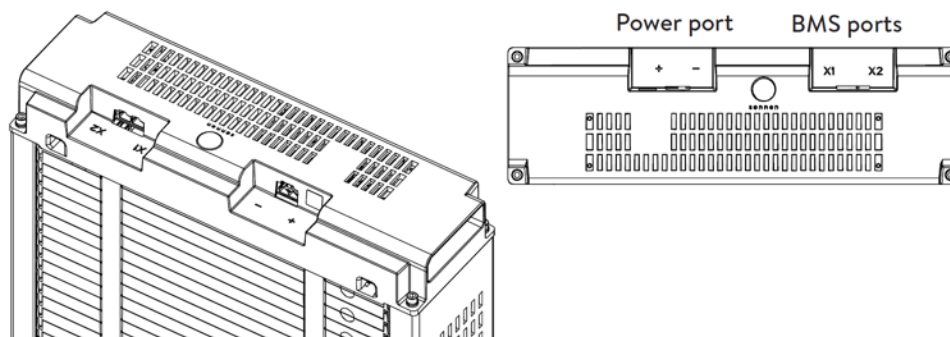

Figure 1: sonnenModule4 battery module

- The battery modules have a nominal voltage of 102.4 VDC and but operate in series which raises the operating voltage above 120 VDC resulting in the application of DVC C.
- The battery modules are utilising high-performance Lithium-Iron-Phosphate (LFP)
- The battery modules contain no metallic Lithium.



The battery modules installed in the storage system are protected by multiple protective devices and can be operated safely. Despite their careful design, the battery cells inside the battery modules may corrode or experience thermal runaway in the event of mechanical damage, heat or a fault.



This can have the following effects:

High heat generation on the surface of the battery cells.

- Electrolyte may escape.
- The escaping electrolyte may ignite and cause an explosive flame.
- The smoke from burning battery modules can irritate the skin, eyes and throat.

Therefore, proceed as follows:

- ▶ Do not open the battery modules.
- ▶ Do not mechanically damage the battery modules (pierce, deform, strip down, etc.)
- ▶ Do not modify the battery modules.

- ▶ Do not allow the battery modules to come into contact with water (except when extinguishing a fire in the storage system).
- ▶ Do not heat the battery modules. Operate them only within the permissible temperature range.
- ▶ Keep the battery modules well away from sources of ignition.
- ▶ Do not short-circuit the battery modules. Do not allow them to come into contact with metal.
- ▶ Do not continue to use the battery modules after a short circuit.
- ▶ Do not deep-discharge the battery modules.

In the event that module contents are released:

- ▶ Do not enter the room under any circumstance.
- ▶ Avoid contact with the escaping electrolyte.
- ▶ Contact the fire services.

## 2.6 Conduct in case of a fire

Fire may occur with electrical equipment despite its careful design. Likewise, a fire in the vicinity of the equipment can cause the storage system to catch fire, releasing the contents of the battery modules.

In the event of a fire in the vicinity of the product or in the storage system itself, proceed as follows:

- ▶ Only firefighters with appropriate protective equipment (safety gloves, safety clothing, face guard, breathing protection) are permitted to enter the room where the burning storage system is located.

There is a danger of electrocution when extinguishing fire while the storage system is switched on. Therefore, before starting to extinguish the fire:

- ▶ Switch off the storage system to electrically isolate it.
- ▶ Switch off the main switch in the building.

If the storage system and/or main switch cannot be safely switched off:

- ▶ Observe the minimum distances specified for the extinguishing agent used. The storage system works with an output voltage of 230 V (AC) and is therefore considered a low-voltage system.
- A storage system fire can be extinguished using conventional extinguishing agents.

- Water is recommended as an extinguishing agent in order to cool the battery modules and therefore, prevent thermal runaway in battery modules which are still intact.

## 3 Product Description

### 3.1 Technical data

<b>sonnenBatterie Evo</b>	
<b>System specifications (AC)</b>	
Nominal voltage	230 V
Nominal frequency	50 Hz
Nominal power rating (@ 40 °C)	5000 W
Rated current	22 A
Rated active power	5000 W
Rated apparent power	6900 VA
Charge/ discharge power	5000 W
Power factor range	0.5 leading ... 0.5 lagging
Short circuit current	454A @ 12.13ms
Mains connection	Single-phase, L / N / PE
Mains topology	TN / TT
Grid integration	AC coupled
Inverter topology	Transformerless
Active anti-islanding method	Integrated
<b>Battery specifications (DC)</b>	
Nominal voltage	102.4 VDC
Battery input voltage	160 - 230 VDC
Operating voltage	204.8 VDC
No. of battery modules	2
Nominal capacity	11 kWh
Usable Capacity (@ 90% DoD)	10 kWh
Max charge/ discharge current (continuous)	40 A
Max charge/ discharge power	5000 W
Short circuit current	2880 A
Cell chemistry	Lithium Iron Phosphate (LiFePO4)
Over-current Protection	Fuse protection
<b>General data</b>	
Dimensions in mm (W x H x D)	710mm x 1400mm x 427mm
Weight (approximate)	165 kg
Ambient temperature range	-5 °C to 45 °C (max. power 5 °C to 35 °C)
Total harmonic distortion	<5%
Inverter efficiency	94.4% peak
On-grid pass-through	35 A
Applications	Time-of-use Self-consumption Backup
System cooling	Forced-air cooling
Communication	Ethernet
Warranty	10 years or 10,000 cycles

### Safety

Protection class	I / PE conductor
Overtoltage category	III
Degree of protection	IP 56
Rated short-withstand current (ICW)	1.5 kA

### Ambient conditions

Environment	Outdoor
Storage temperature range	0 °C ... 40 °C
Transport temperature range	-15 °C ... 50 °C
Max. rel. humidity	90 %, non-condensing
Permissible installation altitude	2,000 m above sea level
Pollution degree	3

### Backup specification

Nominal backup current (Continuous)	22 A
Nominal output voltage	230 V
Nominal power	5000 W
Nominal frequency	50 Hz
Max backup power (Max 30mins)	5300 VA
Max backup power (Max 60s)	7050 VA
Max backup power (Max 300ms)	7600 VA
Maximum compatible PV inverter	6kW

### Certifications

Grid connections	AS/NZS 4777.2:2020
EMC / EMI protection	EN 61000-6-1, EN 61000-6-3, IEC 62040-2
Safety	IEC 62040-1, IEC 62477-1, IEC 62619, IEC 62109-1, IEC 62109-2

### Additional ambient conditions:

- The installation location must not be at risk of flooding.
- Installation room should be ventilated.
- The currently applicable building codes must be observed.
- Even floor, suitable for heavy loads.
- Observe fire control standards.
- Free from corrosive and explosive gases (ammonia content max. 20 ppm).
- Free from dust (especially flour dust or sawdust).
- Free from vibrations.
- Free access to the installation location.
- If possible, no direct sunlight.

### 3.2 Type plate

The type plate for the storage system is located on the outer surface of the system. The type plate can be used to uniquely identify the storage system. The information on the type plate is required for the safe use of the system and for service matters.

The following information is specified on the type plate:

- Item designation
- Item number
- Technical data of the storage system
- Initial installer password

### 3.3 Overview of switch panel

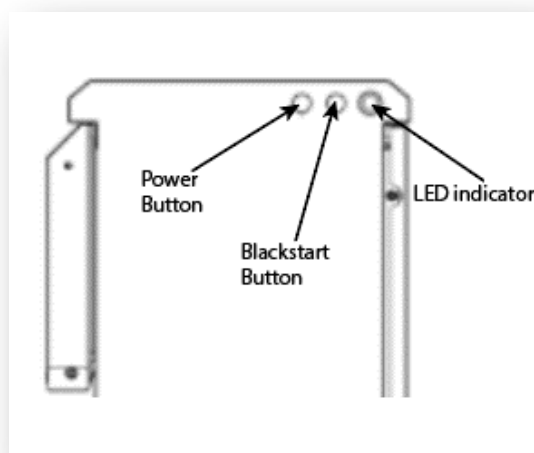

Figure 2: Overview of switch panel

No.	Designation	Function
1	Power Button	Switch for switching the storage system on and off.
2	Blackstart Button	Switch for switching the storage system on during backup mode.
3	LED indicator	LED light indicating the status of the storage system when it is switched on.
4	Type plate	Technical data and other information for identifying the storage system.

Table 2: Function of the switches

### 3.4 System components

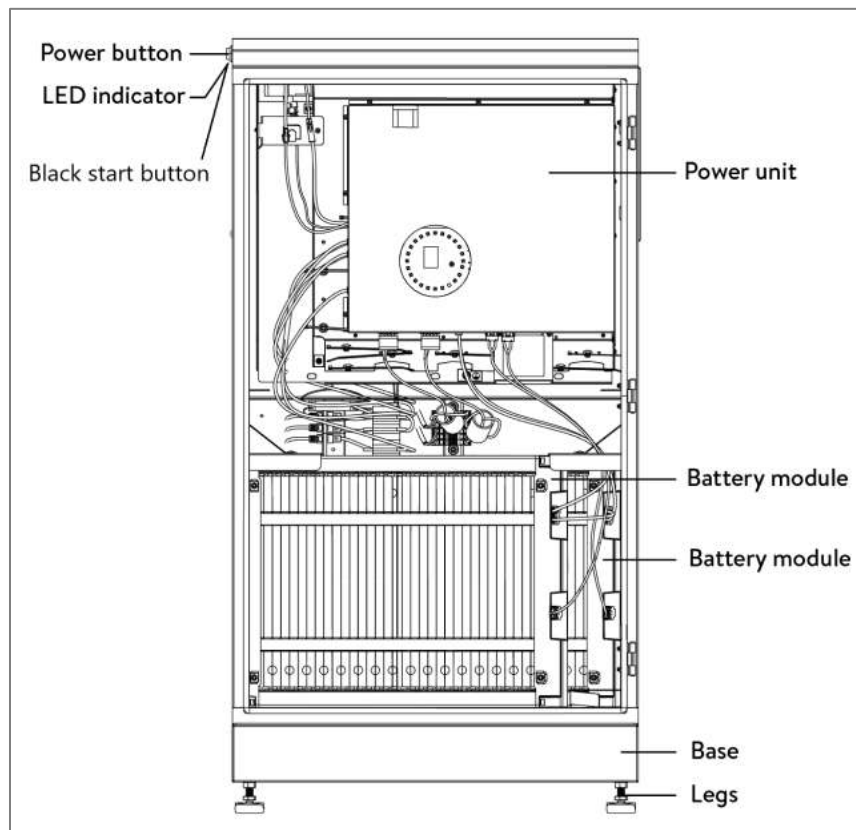











Figure 3: Overview system components

Item	Description	Function
1	Power Unit	Contains the inverter and the control unit
2	Battery Module	Stores energy
3	Base	Contains the air filter
4	Legs	Provide elevation and compensation for uneven grounds
5	Power Button	System startup and shutdown
6	LED Indicator	Indication of the state of operation
7	Blackstart Button	System startup in offgrid condition

### 3.5 Symbols on the storage system

Symbol	Description
	Warning: flammable materials.
	Warning: hazards due to batteries.
	Warning: electrical voltage.
	Warning: electrical voltage. Wait five minutes after switching off (capacitors de-energising time).
	Warning: Equipment with multiple sources of supply (PV generator, AC mains and battery).
	Warning: product is heavy.
	CE mark. The product meets the requirements of the applicable EU directives.
	RCM Mark for Australia and New Zealand.
	WEEE mark. The product must not be disposed of in household waste; dispose of it through environmentally friendly collection centres.
	Observe the documentation. The documentation contains safety information.



### 3.6 Function of the LED indicator

The LED indicator on the left side of the enclosure provides general information about the status of the system.

LED Colour	Description
White pulsating	Normal operation; System is charging/discharging
Green	No grid available; Backup supply active
Orange	No internet connection
Red	Critical Error. Contact sonnen service team.

*Table 3: Function of the LED indicator*

## 4 Function

### 4.1 Basic operating principle

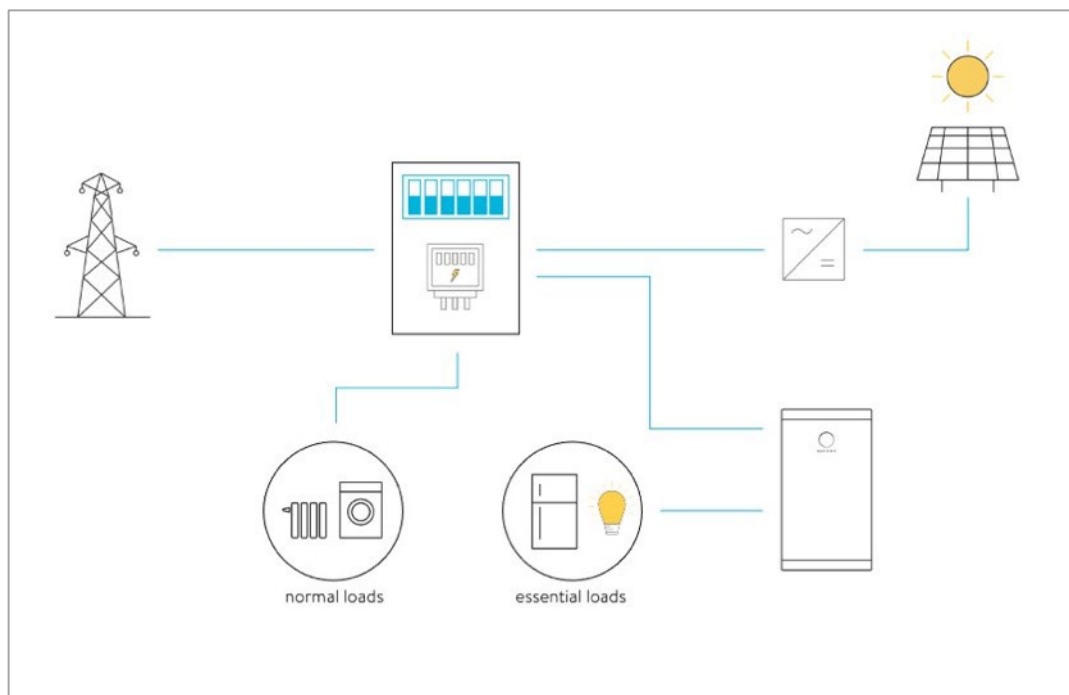

Figure 4: sonnenBatterie Evo Connection Concept

The sonnenBatterie Evo is an intelligent storage system that monitors and controls energy production, consumption, and storage in the house. The storage system is connected to the grid via the main distribution board.

The sonnenBatterie Evo can work with existing or newly installed PV systems. The PV array does not connect to the storage system directly. The storage system uses a power meter and current transforms to monitor PV power generation and energy consumption in the building.

The sonnenBatterie Evo offers three modes of operation: Self-consumption, Backup, and Time of Use.

#### 4.1.1 Self-consumption mode

Self-consumption is the part of the generated PV power that has been either consumed at home or stored in the battery. This is the default mode of operation.

## Generation > Consumption

If the generation of PV power is higher than the consumption such as at midday, there is a surplus of electrical energy. In this case the surplus energy is used to charge the battery of the storage system.

If the entire portion of the surplus cannot be charged into the battery, the remaining surplus is fed into the public electricity grid.

## Consumption > Generation

If the consumption is higher than the generation of PV power such as in the evening, there is a deficit of electrical energy. In this case the battery of the storage system is discharged to even out as much of the deficit as possible. If the entire deficit cannot be compensated by discharging the battery, the remaining deficit is covered by the public electricity grid.

The storage system also acts as a backup power supply, meaning that if the utility grid goes out, your appliances will be powered by the batteries of the storage system conditioned upon installer connection of back up function.

### 4.1.2 Backup mode

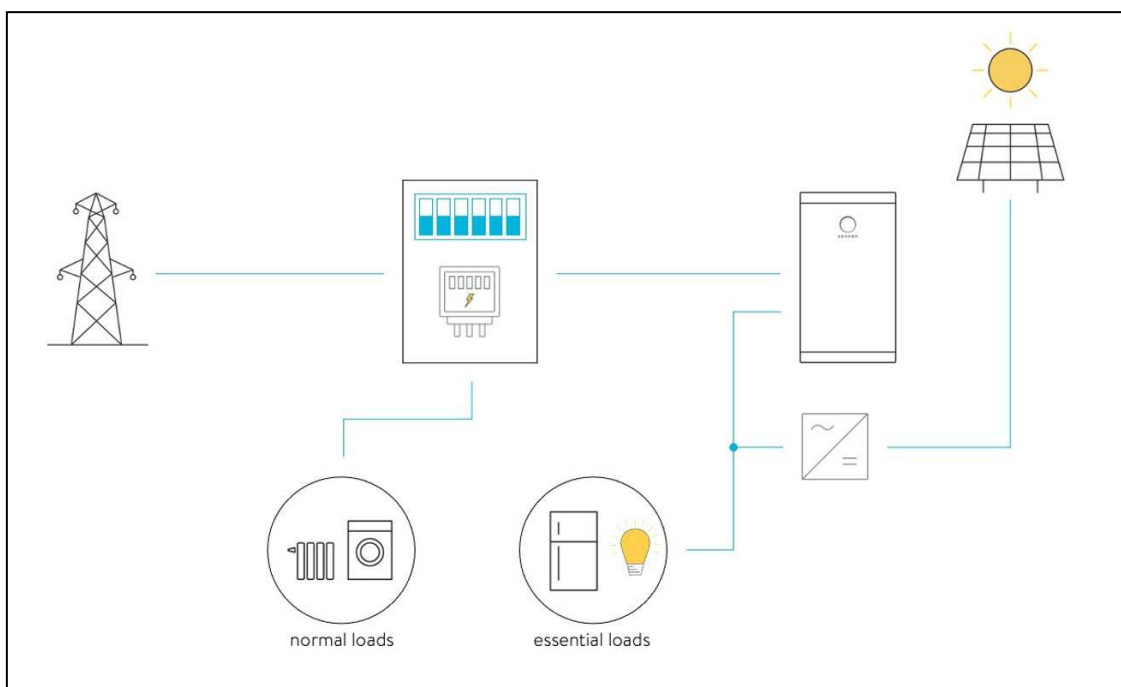

Figure 5: sonnenBatterie Evo Connection Concept

sonnenBatterie Evo storage system automatically switches from grid to backup operation and vice versa. In the event of a grid failure, the storage system automatically detects the grid outage and will disconnect itself from the public electrical mains and will create a micro-grid using the power from the batteries. Appliances connected to essential loads circuit in the house will be supplied with electrical power. Appliances connected to normal loads circuit in the house will not be supplied with electrical power.

During the backup operation, the micro-grid produces grid-quality voltage and frequency so that any grid-connected PV inverter in the micro-grid will continue to operate. Therefore, during backup operation, the essential loads circuit will be powered by the energy stored in the battery modules and the PV energy generated from the PV array. The generated PV power will also charge the battery modules, depending on generation and consumption levels.

The PV array will first power the loads on the essential load circuit, with any excess energy charging the batteries in the storage system. If there is insufficient PV to cover the loads, the storage system will discharge its batteries to meet the demand. The storage system can also turn the PV inverter off if the battery modules become fully charged.

To prevent battery overcharging while in backup mode, the storage system will perform a frequency shift by raising the frequency to a value outside the PV inverter's operating range. This shift in frequency will disconnect the PV inverter from the micro-grid while the storage system will maintain the power supply to the loads. The storage system will reduce the frequency to 50 Hz once the state of charge falls below a certain threshold to allow for a charge event. The PV inverter will then automatically detect the frequency adjustment and re-connect to the micro-grid.

## Microgrid Re-Enabling

If the battery SOC drops to a minimum threshold during backup operation:

1. The micro-grid will be deactivated, and the system will go to 'standby mode'. The essential loads and the external PV inverter on the micro-grid will disconnect consequently.
2. The system will remain in 'standby mode' until the system time reaches the "Reenabling time one", as previously set in the commissioning process. Then, it will

re-enable the micro-grid. The essential loads and the AC-coupled PV inverter will re-connect consequently.

3. If there is sufficient excess PV energy to charge the battery, the micro-grid will be maintained.
4. Otherwise, the micro-grid will be deactivated, and the system will go to 'standby mode' again. The essential loads and the AC-coupled PV inverter will disconnect consequently.
5. The system will repeat steps 2 to 4 according to the "Reenabling time two" and "Reenabling time three", as previously set in the commissioning process. The system will shutdown after the third attempt to prevent further battery discharge.

## Blackstart Functionality

In case of a grid-outage the storage system will automatically enable and switch-over to microgrid operation depending on the state-of-charge of the batteries. Alternatively, the system operator has the ability to manually switch on the storage system without the grid being present by using the blackstart button. In the process, the storage system will also activate the microgrid.

For correct operation, please follow the steps below:

1. Ensure the storage system is turned on prior to using the blackstart button. Green power button in ON position.
2. Switch on the storage system using the green power button.
3. Press and hold the blackstart button for about 60 seconds.

If there is sufficient *excess PV energy* to charge the battery, the micro-grid will be maintained.

Otherwise, the micro-grid will be disconnected, and the system will go to 'standby mode' again. The essential loads and the AC-coupled PV inverter will disconnect consequently.

### 4.1.3 Time-of-Use mode

This mode is similar in function to self-consumption except that the storage system will charge the batteries from the grid during the specific time windows selected by the customer. By setting the storage system to time of use mode, customers can store

electricity in the battery when electricity prices are low, and then use this stored electricity to supply the household appliances at times of peak rate. The batteries are prevented from discharging during the selected windows of time of use.

If your electricity provider company offers you time of use electricity tariffs, in which there is a price difference between the peak and off-peak rates, you may consider setting the storage system to time of use mode.

Please contact your sonnen support team to set up the ToU mode.

## 5 Operating the storage system



Opening of the storage system by unauthorised persons.  
Danger to life due to electrocution.

- ▶ The storage system must only be opened by authorised electricians.
- ▶ Electrical work on the storage system and the associated electrical distributor must only be carried out by authorised electricians.



The storage system can only be switched on if the AC grid has been switched on first.

### 5.1 Switching the storage system on

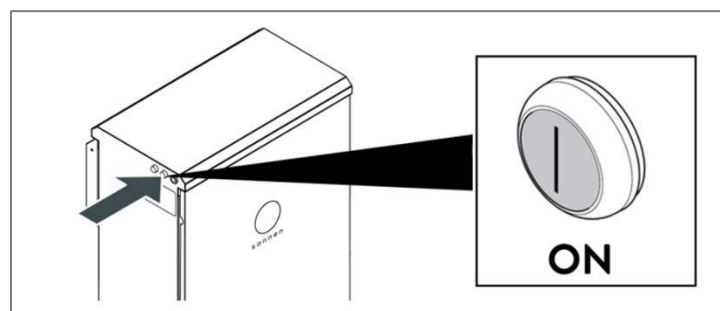

Figure 6: Startup procedure

To turn the system on, please follow the sequence below:

1. Switch on the BESS Main Switch located in the switchboard
2. Switch on the Main Switch for backup supply located in the switchboard or dedicated subboard
3. Switch on the BESS AC isolator adjacent to the system (if available)
4. Switch on the BESS Backup isolator adjacent to the system (if available)
5. Switch on the BESS using the green power button located on the left side of the enclosure

Notice: ON position is extended OUT!

## 5.2 Switching the storage system off

### NOTICE

Deep-discharge of the battery modules.

Destruction of the battery modules!

- ▶ Do not disconnect the storage system from the public electricity grid for long periods of time.
- ▶ Never continue to operate battery modules which have been deep-discharged.

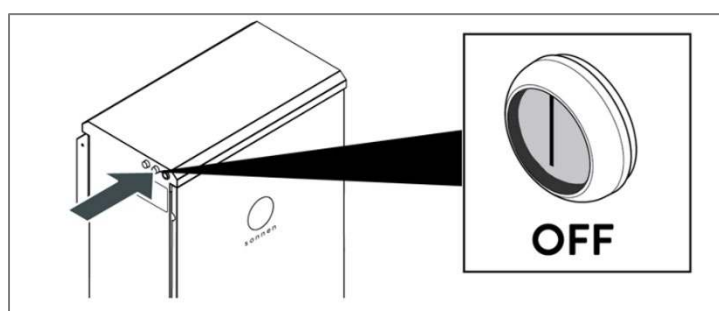

Figure 7: Shutdown procedure

To turn the system off, please follow the sequence below:

1. Switch off the BESS using the green power button located on the left side of the enclosure  
Notice: OFF position is pushed IN!
2. Switch off the BESS AC isolator adjacent to the system (if available)
3. Switch off the BESS Backup isolator adjacent to the system (if available)
4. Switch off the BESS Main Switch located in the switchboard
5. Switch off the Main Switch for backup supply located in the switchboard or dedicated subboard.



## 6 Customer portal

The sonnen customer portal is used to monitor real-time and historical data of the storage system and other sonnen products and configure settings. You can access the customer portal at any time. In addition to an overview of your products and contracts, you will also find interesting information on the sonnenCommunity and sonnen's energy services.

### 6.1 Logging into the customer portal

You can access the customer portal using the 'my sonnen' App on your smart device or using the portal on a web browser.

To use the customer portal, you need a sonnen account. If you already have a sonnen account, you can log into the customer portal directly. If not, you can create a personal sonnen account as follows:

Start "my sonnen" app on your smart device or enter the following address into a web browser: [my.sonnen.de](https://my.sonnen.de).

Click on the corresponding button to register and create a sonnen account.

After creating the sonnen account you can use this in future to log in and access all sonnen digital products.

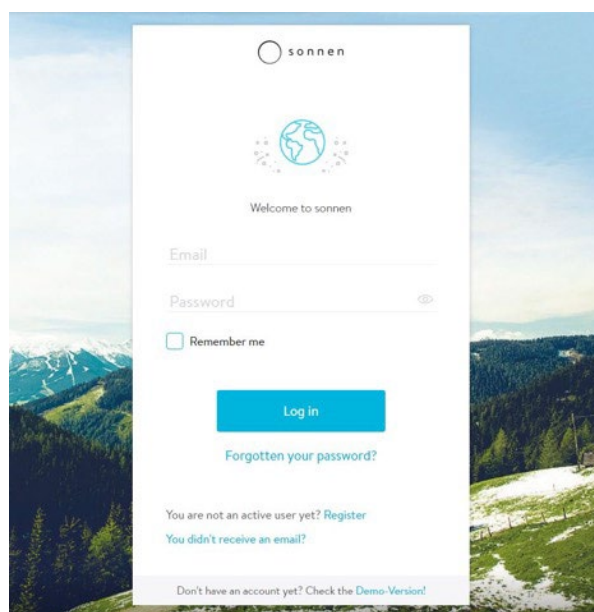

Figure 8: Customer portal register and login page

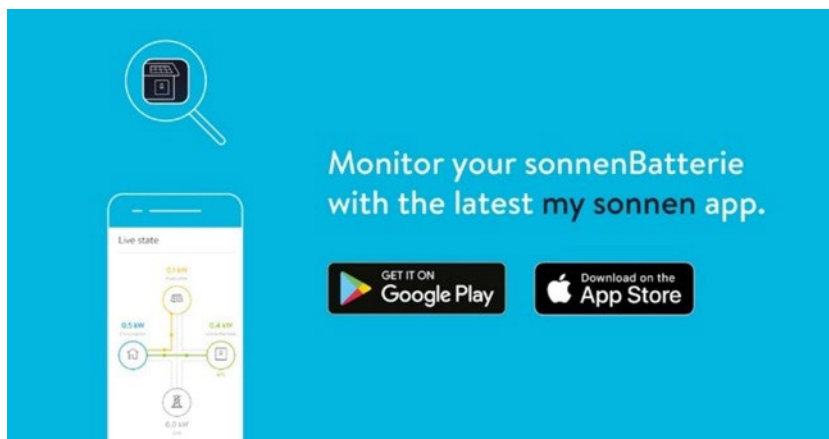

Table 4: my sonnen App

## 6.2 Using the customer portal

### 6.2.1 Dashboard

A fundamental part of the customer portal is the graphic display of the data from your storage system and of processes within your building.

The interactive dashboard page shows a summary of all the information from available products and services.

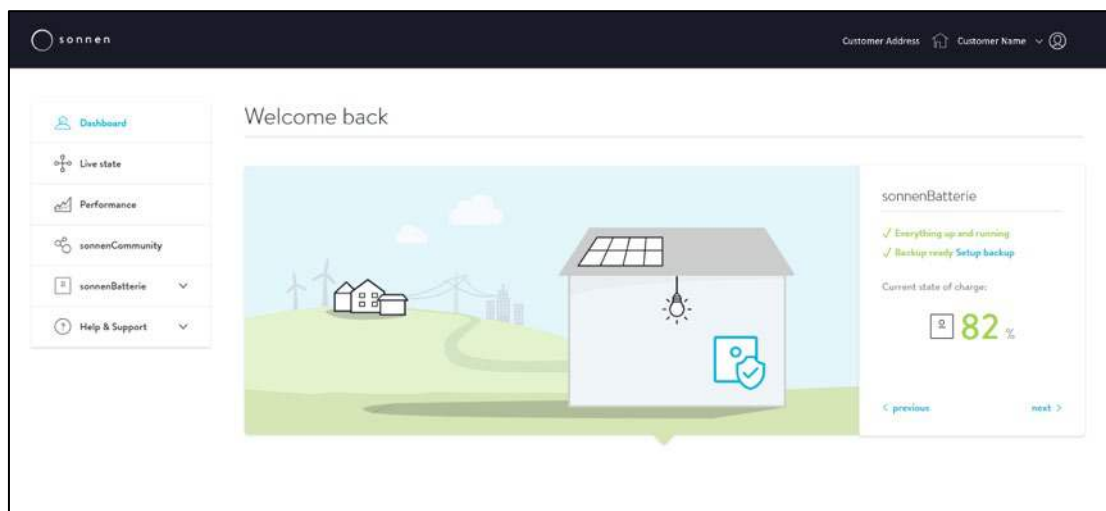

Figure 9: Overview of customer portal Dashboard

### 6.2.2 Live state

The Live State offers a quick overview of the current distribution of electricity within your household. The different displays are always up-to-date and continuously supplied with live data.



Figure 10: Overview of live state

### 6.2.3 Performance

You can easily track the activities of your household throughout the day via the two sections Performance and Statistics.

The Performance page displays all relevant energy flows of PV generation, home consumption and state of charge of the batteries in a graph. The power graph presents the different energy flows in relation to time. You can hover your mouse cursor over the graph to see the exact values for the energy flows at each point of time. You can click on the date above the graph to view the system performance on that day.

Clicking on the desired energy flow (e.g., consumption) shows or hides this flow in the graph.



Figure 11: Overview of system performance

## Statistics

The statistics section is located below the power graph on the performance page. This section provides simplified daily, monthly, or yearly statistics.



Figure 12: Overview of system statistics

Two pie charts are also shown in this section. The pie charts always refer to the time frame shown in the graph and give an overview of Independence and Grid Purchase and Self-consumption and Grid Feed-in.

### Production pie chart

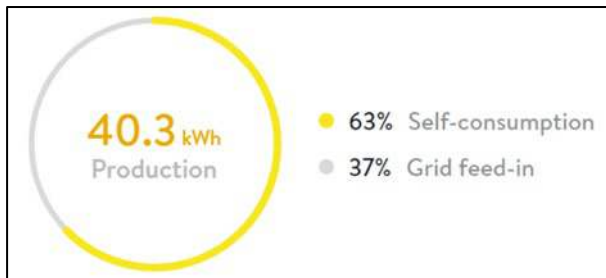

Figure 13: Production pie chart

This pie chart represents the PV power gained during the selected time frame and gives you an insight of Self-consumption and Grid feed-in. Self-consumption is the part of the generated PV power that has not been fed into the grid, but instead has been consumed at home or temporarily stored in the battery. Grid feed-in is the amount of the excess PV power that is fed into the grid.

## Consumption pie chart



Figure 14: Consumption pie chart

This pie chart represents the household consumption during the selected time frame and gives you an insight of Independence and Grid purchase. Independence is the part of the consumed power that was not taken from the grid. Grid purchase is the amount of power that is taken from the grid.

## 6.2.4 sonnenBatterie page

You can find an overview of the current status of your sonnenBatterie and information on your existing sonnen accessories on this page.

### Overview

Overview section provides information about the storage system. Under “My sonnenBatterie”, you can find the model and serial number, the installed battery capacity, operating mode (self-consumption, backup or time of use).

Under “Status”, you can view battery state of charge, the number of charge cycles and the backup buffer. You can set or change the backup buffer via the Edit button.

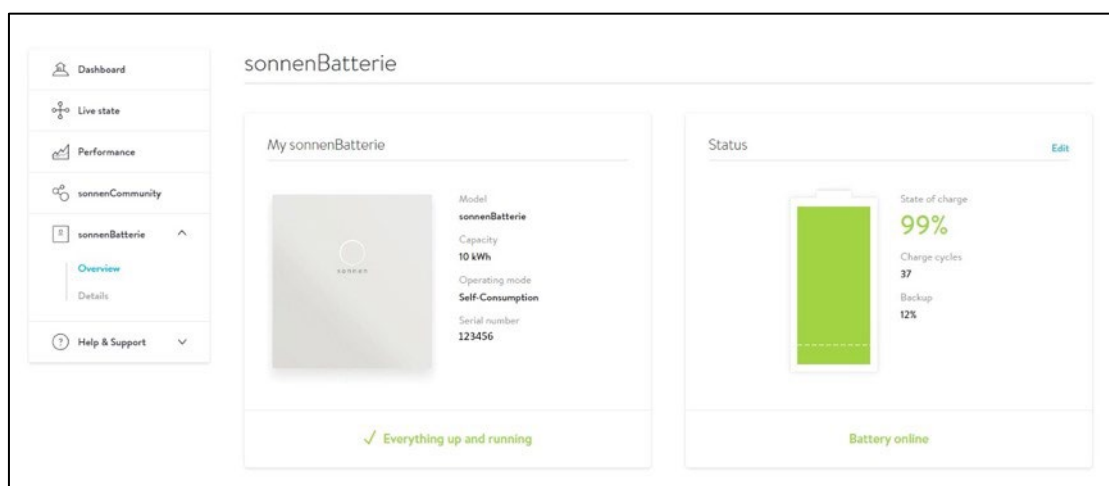

Figure 15: my sonnenBatterie overview

## Details

In the Details section, you can access more detailed information and technical data of the storage system such as software version, installation date and address, battery module technical details including maximum power of the battery, number of battery modules, number of charge cycles and battery technology.

The Downloads section provides access to the operation manuals of the storage system.

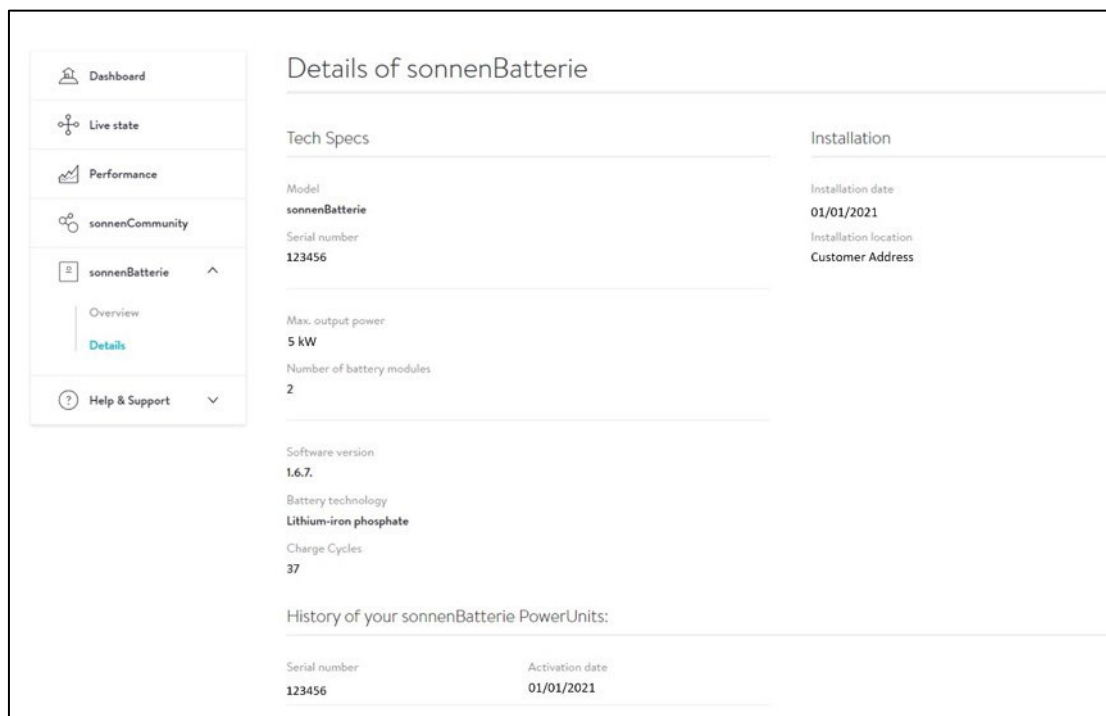

Figure 16: my sonnenBatterie details

### 6.2.5 Help and Support

This section displays the contact details for the local service team. In addition, it gives you the ability to send out a service request to the service team directly from the customer portal.

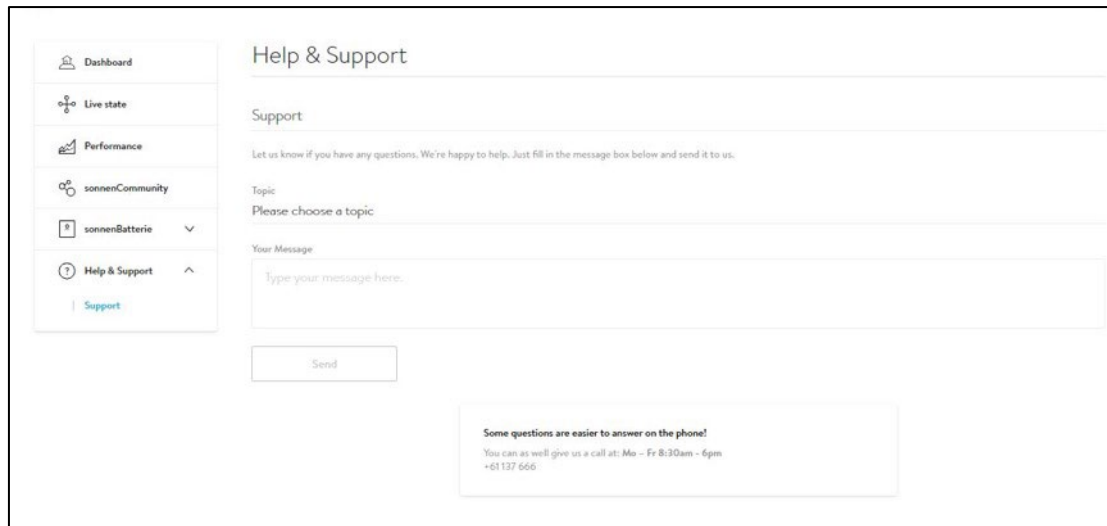

Figure 17: Help and support

## 6.2.6 Personalising sonnen account

To access your account settings, click on the white arrow next to your name and then click on “My Account”.

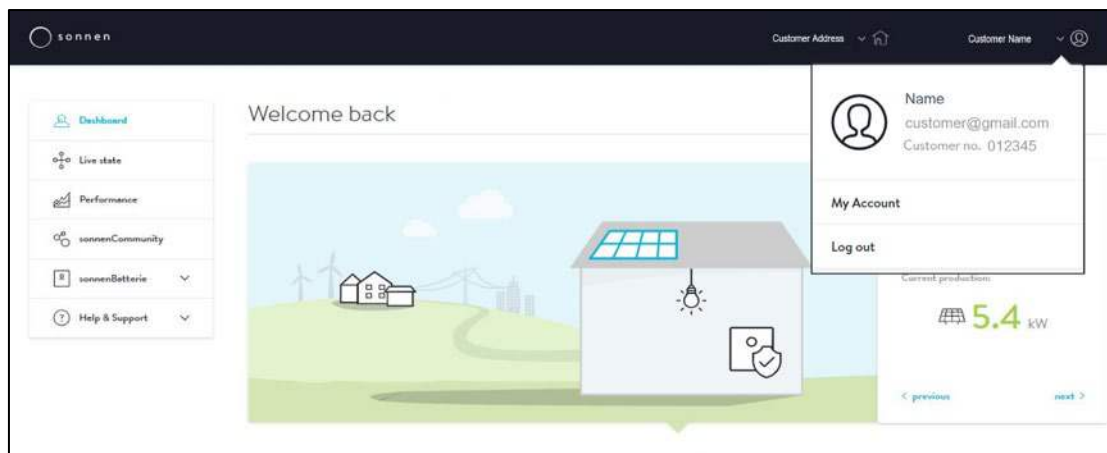

Figure 18: Access sonnen account

### About me

Your personal details can be viewed at “About me” section. To change or update your personal details, please contact the service team at sonnen Australia.

### Password

You can change your sonnen account password by clicking on the Password section under ‘My Account’ menu.



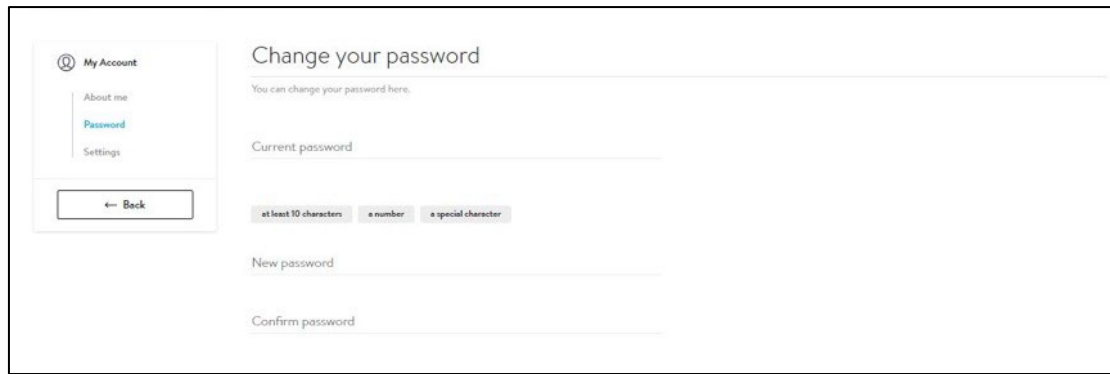

Figure 19: Change password

## Settings

Privacy permissions can be accessed in the Settings section. The ‘Service function’ under Privacy permission is activated by default. With this function activated, you give permission that your installer and/or retailer is able to monitor your storage system online. This allows your service partner to respond in case of technical issues of your storage system.

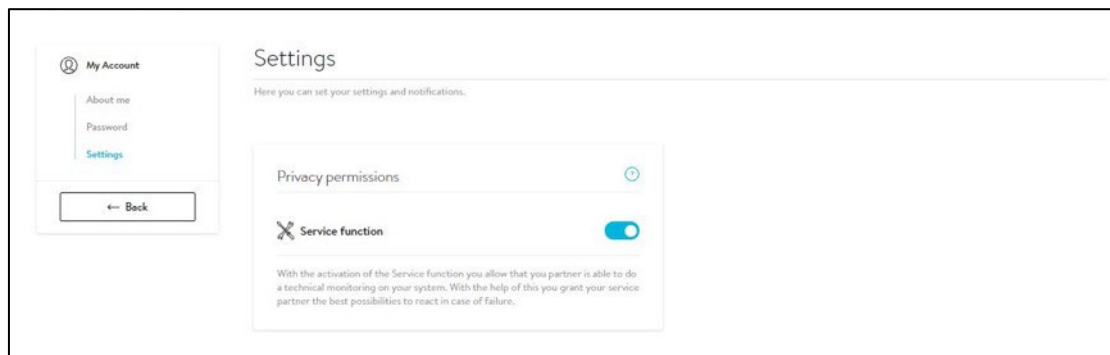

Figure 20: Privacy permission

## 7 Maintenance

For fault-free, safe, reliable, and long-lasting operation of the storage system, it is essential to carry out regular function checks and cleaning.

The battery modules installed in the storage system do not require maintenance.

Interval	Actions
Every 2 weeks	<ul style="list-style-type: none"> <li>▶ Check for any functional errors of the system in the portal.</li> </ul>
Every 6 months	<ul style="list-style-type: none"> <li>▶ Carefully observe the system for any visible damage</li> <li>▶ Carefully listen to any abnormal noise during operation of the system</li> <li>▶ Ensure the ground and the enclosure are clean and tidy</li> <li>▶ Ensure the air vents at the back have a clear path for the air flow</li> <li>▶ Clean the filter mat located in the base using warm water</li> <li>▶ Check for any loose or damaged connections, wires, and conduit</li> <li>▶ Carefully clean the outside of the storage system with a clean, moist cloth. For tougher dirt, use a small amount of household dishwashing detergent on a moist cloth.</li> </ul>

## 8 Decommissioning

### NOTICE

#### Deep-discharge of the battery modules.

Destruction of the battery modules!

- ▶ Do not disconnect the storage system from the public electricity grid for long periods of time.
- ▶ Never continue to operate battery modules which have been deep-discharged.

- ▶ Follow the shutdown instruction in section 5.2.

## 9 Troubleshooting

Disturbance	Possible reason	Correction
No connection to the web interface of the storage system ( <a href="https://findmy.sonnen-batterie.com">https://findmy.sonnen-batterie.com</a> ) or to the internet portal ( <a href="https://my.sonnen.de">my.sonnen.de</a> ).	No connection between the storage system and the server.	<ul style="list-style-type: none"> <li>▶ Ensure the ethernet line between the storage system and the router of the home network is correctly connected.</li> <li>▶ Ensure that the router of the home network allows connections on the following ports:                             <ul style="list-style-type: none"> <li>- TCP ports: 443 (https); 18883 (MQTT- TLS)</li> <li>- UDP ports: 123 (NTP); 1196 (VPN)</li> </ul> </li> </ul>
The storage system stopped charging or discharging.	Software or hardware related issue.	<ul style="list-style-type: none"> <li>▶ Restart the storage system by following the shutdown and start-up procedure in section 5.</li> <li>▶ If the issue persists, contact the sonnen service</li> </ul>
The status LED pulses orange.	The internet connection to the storage system has been interrupted.	<ul style="list-style-type: none"> <li>▶ Check whether the home network router is able to establish an internet connection.</li> </ul>

		<p>If so:</p> <ul style="list-style-type: none"> <li>▶ Ensure that the network line for the storage system is connected to the home network router.</li> </ul>
The status LED illuminates red.	The storage system has detected a problem that is preventing normal operation or may cause damage to the storage system.	<ul style="list-style-type: none"> <li>▶ Contact your installer or sonnen service team to resolve the issue.</li> </ul>
The status LED pulses continuously green or pulses green and turns off after about 5 minutes.	The storage system is not connected to the public electricity grid.	<ul style="list-style-type: none"> <li>▶ Check that the circuit breaker in the supply line of the storage system is switched on.</li> </ul> <p>If so: The public electricity grid does not provide any electrical energy (grid outage).</p> <ul style="list-style-type: none"> <li>▶ The storage system will reconnect and resume normal operation once the grid becomes available.</li> </ul>
	The storage system is not connected to the public electricity grid and is in backup operation.	No troubleshooting necessary.

## 10 Uninstallation & Disposal

### 10.1 Uninstallation



#### Improper uninstallation of the storage system

Danger to life due to electrocution!

- ▶ The storage system must be only uninstalled by an authorised electrician.

### 10.2 Disposal

**⚠ CAUTION**

**Improper transport of battery modules**

Fire outbreak at battery modules or emission of toxic substances!

- ▶ Transport the battery modules in their original packaging only. If you no longer have the original packaging, new packaging can be requested from sonnen Australia.
- ▶ Never transport damaged battery modules.

**⚠ CAUTION**

**Improper disposal of battery modules**

Explosion or fire outbreak at battery modules or emission of toxic substances!

- ▶ Do not dispose of batteries in fire.

The storage system and the batteries it contains must not be disposed of as domestic waste!

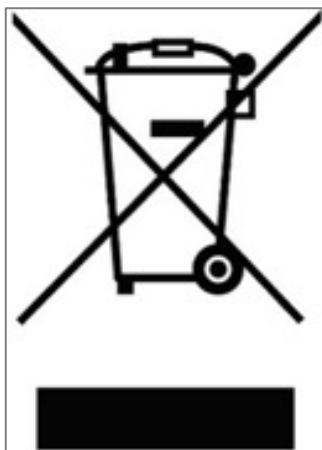

- ▶ Dispose of the storage system and the batteries it contains in an environmentally friendly way through suitable collection systems.



**sonnen Australia Pty Ltd**

Tenancy 6, Lionsgate Business Park  
180 Philip Highway  
Elizabeth South SA 5112 Australia

Part Number: 5000611 Rev: 000